

Whitco[®]
SECURING YOUR HOME™

Window Locks





CYL4™ is a patented innovation that allows ASSA ABLOY window locks and patio bolts to be keyed to door locks that use the most common key type (C4), thus providing customers with the added convenience of having to use only one key around the home.

Most Australian door locks are operated by a C4 key. Traditional window locks are incompatible with a C4 key. Therefore homeowners are required to carry at least one key for their door locks, and a different key (or keys) for their window locks.

The introduction of ASSA ABLOY's unique CYL4™ technology has revolutionised home locking security. Our new high security window lock and patio bolt ranges incorporate the patented CYL4™ cylinder which is quickly and easily keyed alike to your customer's 5 pin C4 door key.



The ASSA ABLOY Key Gauge, provided in the CYL4™ Keying Kit, allows fast and accurate determination of the key code.

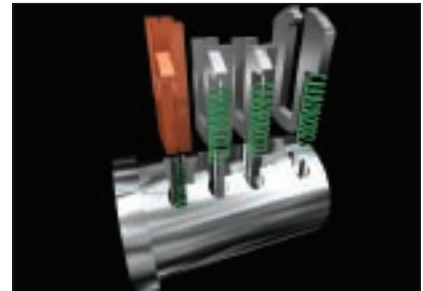

The patented CYL4™ cylinder has been designed to retain its wafers when the key is removed. This makes re-keying the CYL4™ cylinder quick and easy for retailers and locksmiths alike.



There are 10 CYL4™ wafers numbered 0-9, that cover the 10 depths of a C4 key. Six wafers are arranged in pairs to match the first 3 cuts of the customer's key.



Using the CYL4™ Keying Kit, you can re-key any ASSA ABLOY CYL4™ window lock or patio bolt to the customer's C4 key in just a few minutes. EASY!

Window Locks

Contents

Description	Page
CYL4™ Push Lock	4-5
CYL4™ Mini Push Lock	6
CYL4™ Multi Bolt	7
CYL4™ Patio Bolt	8-9
CYL4™ Window Bolt	10
CYL4™ Mini Window Bolt	11
Sash Locks	12-15
Sliding Window Lock	16-18
Series 22 Window Catch	19
Series 25 Window Lock	20

Window Locks

CYL4™ Push Lock



Aluminium

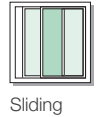

Application / Description

High security CYL4™ sliding window lock with concealed fixing

Features and Specifications

- CYL4™ One Key Security - Can be matched to most door locks for one key convenience
- High security, robust construction, resists attack
- Added security for sliding windows
- Solid zinc diecast metal body
- Simply push button to lock
- Enables secure ventilation
- Standard and one way fixing screws supplied
- Concealed fixing for security and style
- 2 drilling jigs included
- Side fix packer / jig
- Installation kit included for front and side fixing
- Display and Trade pack available
- Made in Australia with imported components

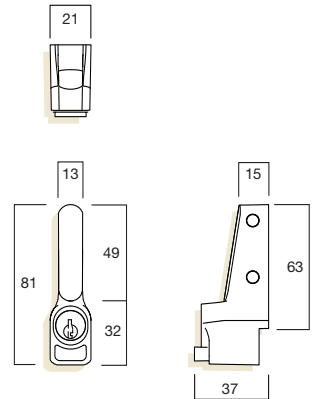

Keying

- CYL4™ cylinder - Can be Keyed Alike to all door locks that use a 5 pin key with a C4 profile, and to CYL4™ window locks.
- Or - 5 disc wafer cylinder - Can be Keyed Alike to other Whitco 5 disc products.
- Two Whitco keys included

Non Standard Finishes

Other polyester power coat finishes available on application

Standard Finishes

Available in polyester powder coat finishes

- | | | | |
|--------------------------------------|--------------------------------------|-----------------------------------|-----------------------------------|
| <input type="checkbox"/> Silver 11 | <input type="checkbox"/> Mahogany 12 | <input type="checkbox"/> White 16 | <input type="checkbox"/> Black 17 |
| <input type="checkbox"/> Primrose 19 | <input type="checkbox"/> Doeskin 23 | | |

Window Locks

Ordering

•• Denotes finish. See price list for available pack / finish combinations

Display Pack

Includes Face Fix Drilling Jig, Side Fix Drilling Jig & Packer, 1.5mm, 2.5mm & 5mm Packers

Single Pack - CYL4 Cylinder	W22001••
Quad Pack - Keyed Alike - CYL4 Cylinder	W22004••

Fabricator Pack

No Drill Jig or Instructions included

CYL4 Cylinder	W22014••C4
5 Disc Wafer Cylinder	W22014••D5

Lock with Offset Keeper

Includes Packers, Rivets and Screws

CYL4 Cylinder	W22016••C4
5 Disc Wafer Cylinder	W22016••D5

Trade Pack

Includes Face Fix Drilling Jig, Side Fix Drilling Jig & Packer, 1.5mm, 2.5mm & 5mm Packers

CYL4 Cylinder - Keyed Alike	W22013••C4
5 Disc Wafer Cylinder - Keyed Alike	W22013••D5

Lock with Centre Keeper

Includes Packers, Rivets and Screws

CYL4 Cylinder	W22012••C4
5 Disc Wafer Cylinder	W22012••D5

Lock with No Cylinder

Includes Centre Keeper, Packers, Rivets and Screws

W22011••

Accessories

Plain Centre Fix Keeper	Black	W2200317
Plain Offset Fix Keeper	Black	W2200217
Pushlock Packer Set - 1.5mm, 2.5mm		W22005••
Pushlock Packer Set - 5mm & Side Fix Packer		W22006••

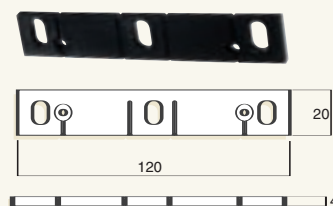

W2200217 and W2200317

Window Locks

CYL4™ Mini Push Lock



Sliding

Casement

Awning

Double Hung

Application / Description

High security CYL4™ compact window lock

Features and Specifications

- CYL4™ One Key Security - Can be matched to most door locks for one key convenience
- High security, robust construction, resists attack
- Simply push button to lock
- Solid zinc diecast metal body
- Stainless steel ferrule included
- Standard and one way fixing screws supplied
- Suits a wide variety of applications
- Display and Trade Pack available
- Made in Australia with imported components



Keying

- CYL4™ cylinder - Can be Keyed Alike to all door locks that use a 5 pin key with a C4 profile, and to CYL4™ window locks.
- Or - 5 disc wafer cylinder - Can be Keyed Alike to other Whitco 5 disc products.
- Two Whitco keys included

Non Standard Finishes

Other finishes available on application

Accessories

No accessories are available for this product

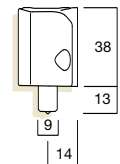
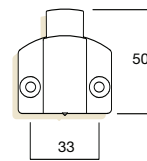
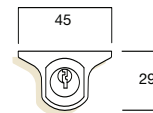

UNLOCKED POSITION

LOCKED POSITION

Standard Finishes

Available in polyester powder coat finishes



Silver 11



Mahogany 12



White 16



Black 17



Primrose 19



Doeskin 23

Ordering

- Denotes finish. See price list for available pack / finish combinations

Display Pack

Includes Stainless Steel Ferrule

Single Pack - CYL4 Cylinder

W22080••

Trade Pack

Includes Stainless Steel Ferrule

CYL4 Cylinder - Keyed Alike

5 Disc Wafer Cylinder - Keyed Alike

W22081••C4

W22081••D5

Window Locks

CYL4™ Multi Bolt



Sliding



Casement



Awning



Double Hung

Application / Description

High security CYL4 Multibolt window lock with concealed fixing

Features and Specifications

- CYL4™ One Key Security - Can be matched to most door locks for one key convenience
- High security, robust construction, resists attack
- Concealed fixing for security and style
- Versatile face fix or side fix design
- Key to lock, key to unlock
- Suits a wide variety of applications
- Enables secure ventilation - (Sliding & Double Hung applications)
- Standard and one way fixing screws supplied
- Stainless steel ferrule for timber applications
- Ideal for double hung windows
- Strong 8mm steel bolts provided
- 3 bolt types supplied
- Solid zinc diecast metal body
- Display and Trade Pack available
- Made in Australia with imported components

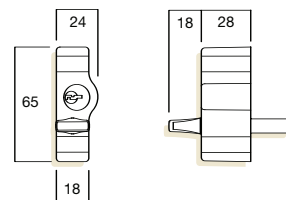

Keying

- CYL4™ cylinder - Can be Keyed Alike to all door locks that use a 5 pin key with a C4 profile, and to CYL4™ window locks.
- Or - 5 disc wafer cylinder - Can be Keyed Alike to other Whitco 5 disc products.
- Two Whitco keys included

Non Standard Finishes

Other finishes available on application

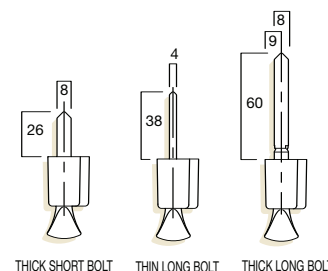
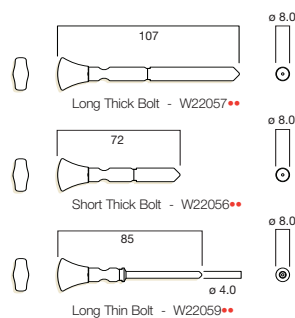

Standard Finishes

Available in polyester powder coat finishes

Silver 11	Mahogany 12	White 16	Black 17
Primrose 19	Doeskin 23		

Ordering

** Denotes finish. See price list for available pack / finish combinations

Display Pack

Includes Short and Long Thick Bolt, Long Thin Bolt and Side Fix Packer

Single Pack - CYL4 Cylinder	W22051**
Quad Pack - Keyed Alike - CYL4 Cylinder	W22050**

Trade Pack

Includes Short and Long Thick Bolt, Long Thin Bolt and Side Fix Packer

CYL4 Cylinder - Keyed Alike	W22053**C4
5 Disc Wafer Cylinder - Keyed Alike	W22053**D5

Accessories

Short Thick Bolt	W22056**
Long Thick Bolt	W22057**
Long Thin Bolt	W22059**

Window Locks

CYL4™ Patio Bolt



Application / Description

Premium high security CYL4™ Patio Bolt with concealed fixing

Features and Specifications

- CYL4™ One Key Security - Can be matched to most door locks for one key convenience
- High security, robust construction, resists attack
- Solid zinc diecast metal body
- Concealed fixing for security and style
- Key to lock, key to unlock
- Strong 9.5mm steel bolt
- 49mm bolt extension
- Bolt engages without locking for safety
- Reversible bolt for left or right handed installation
- Stainless steel ferrule for timber applications
- Allows door to be locked in closed or venting positions - (Sliding door applications)
- Stainless steel keeper for use when bolt doesn't engage door frame
- Extended (78mm bolt extension) versions available
- Single and Twin Keyed Alike display packs available
- Display and Trade Pack available
- Made in Australia with imported components

Keying

- CYL4™ cylinder - Can be Keyed Alike to all door locks that use a 5 pin key with a C4 profile, and to CYL4™ window locks.
- Or - 5 disc wafer cylinder - Can be Keyed Alike to other Whitco 5 disc products
- Two Whitco keys included

Non Standard Finishes

Other polyester powder coat finishes available on application

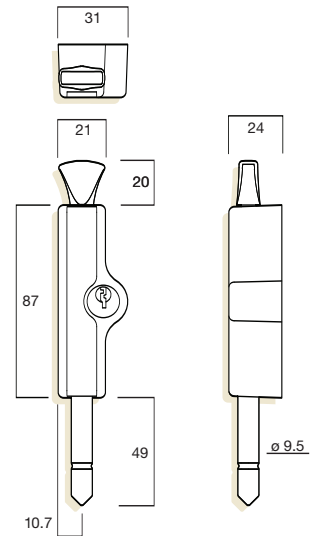
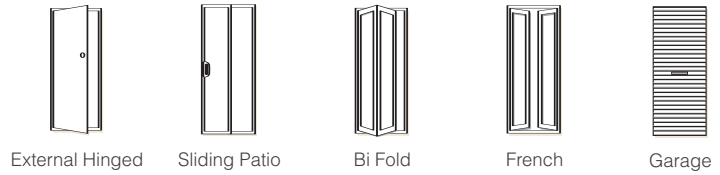





Window Locks

CYL4™ Patio Bolt

Standard Finishes

Available in polyester powder coat finishes

 Silver 11	 Mahogany 12	 White 16
 Black 17	 Primrose 19	 Doeskin 23

These finishes are an indicative representation, actual product finishes may vary.

Ordering

•• Denotes finish. See price list for available pack / finish combinations

Display Pack - Includes 2 x Stainless Steel Ferrules, 4mm Packer and Flat Keeper

Single Pack - CYL4 Cylinder W22061••

Twin Pack - Keyed Alike - CYL4 Cylinder W22068••

Trade Packs - Includes 2 x Stainless Steel Ferrules, 4mm Packer and Flat Keeper





CYL4 Cylinder - Keyed Alike W22063••C4

5 Disc Wafer Cylinder - Keyed Alike W22063••D5

No Cylinder W22070••

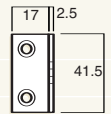
With Extended Bolt - Keyed Alike W2207517

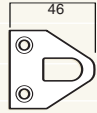
Accessories

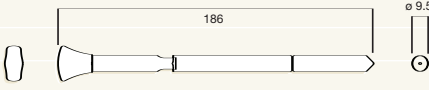
Angle Keeper -	Zinc plated steel	W2206701	  
Flat Keeper -	Zinc plated steel	W2206901	
4mm Packer-		W22072••	  
-		W22073••	
Extended Bolt Only-	Silver	W2206611	
-	Mahogany	W2206612	
-	White	W2206616	
-	Black	W2206617	

W2206701

W2206901

W22066••

Window Locks

CYL4™ Window Bolt



Sliding



Casement



Awning



Double Hung

Application / Description

High security CYL4 multi-purpose window bolt with concealed fixing

Features and Specifications

CYL4™ One Key Security - Can be matched to most door locks for one key convenience
High security, robust construction, resists attack

Concealed fixing for security and style

Key to lock, key to unlock

Strong 9.5mm steel bolt

Bolt engages without locking for safety

Allows window to be locked in closed or secure ventilation position (sliding and double hung windows)

Reversible bolt for left or right handed installation

Solid zinc diecast metal body

Stainless steel ferrule for timber applications

Display and Trade Packs available

Made in Australia with imported components

Keying

CYL4™ cylinder - Can be Keyed Alike to all door locks that use a 5 pin key with a C4 profile, and to CYL4™ window locks.

Or - 5 disc wafer cylinder - Can be Keyed Alike to other Whitco 5 disc products.

Two Whitco keys included

Non Standard Finishes

Other finishes available on application

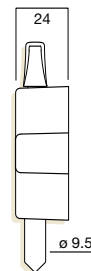
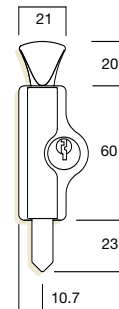
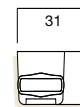

Standard Finishes

Available in polyester powder coat finishes



Silver 11



Mahogany 12



White 16



Black 17



Primrose 19



Doeskin 23

Ordering

•• Denotes finish. See price list for available pack / finish combinations

Display Pack

Includes Stainless Steel Ferrule and 4mm Packer

Single pack

W22031••

Trade Pack

Includes Stainless Steel Ferrule and 4mm Packer

CYL4 Cylinder - Keyed Alike

W22033••C4

5 Disc Wafer Cylinder - Keyed Alike

W22033••D5

Accessories

Angle Keeper -

Zinc plated steel

W2206701

Flat Keeper -

Zinc plated steel

W2206901

Window Locks

CYL4™ Mini Window Bolt



Double Hung



Sliding

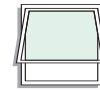

Awning



Casement

Application / Description

High security CYL4 compact window bolt with concealed fixing

Features and Specifications

CYL4™ One Key Security - Can be matched to most door locks for one key convenience
 High security, robust construction, resists attack
 Concealed fixing for security and style
 Key to lock, key to unlock
 Strong 8mm steel bolt
 Bolt engages without locking for safety
 Enables a secure ventilation position (sliding and double hung windows)
 Reversible bolt for left or right handed installation
 Solid zinc diecast metal body
 Stainless steel ferrule for timber applications
 Suits a wide variety of applications
 Display and Trade Packs available
 Made in Australia with imported components



Keying

CYL4™ cylinder - Can be Keyed Alike to all door locks that use a 5 pin key with a C4 profile, and to CYL4™ window locks.
 Or - 5 disc wafer cylinder - Can be Keyed Alike to other Whitco 5 disc products.
 Two Whitco keys included

Non Standard Finishes

Other finishes available on application

Accessories

Stainless steel ferrule

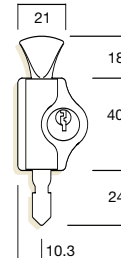
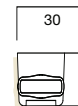

Standard Finishes

Available in polyester powder coat finishes

Silver 11	Mahogany 12	White 16	Black 17
Primrose 19	Doeskin 23		

Ordering

•• Denotes finish. See price list for available pack / finish combinations

Display Pack

Includes Stainless Steel Ferrule and 4mm Packer

Single Pack - CYL4 Cylinder W22231••

Trade Pack

Includes Stainless Steel Ferrule and 4mm Packer

CYL4 Cylinder - Keyed Alike W22230••C4

5 Disc Wafer Cylinder - Keyed Alike W22230••D5

Window Locks

Keyed Sash Lock



Aluminium



Timber



Double Hung

Application / Description

Lockable swivel action double hung window lock

Features and Specifications

- Swivel type two way action
- Key to lock and unlock
- Optional one way screws
- Range of keepers for timber and aluminium window applications
- Standard and wide base available

Display and Trade pack available
Australian made with imported cylinder

Keying

- 5 disc wafer cylinder
- Two Whitco chrome plated keys
- Can be key alike to other Whitco 5 disc products

Non Standard Finishes

Other finishes available on application

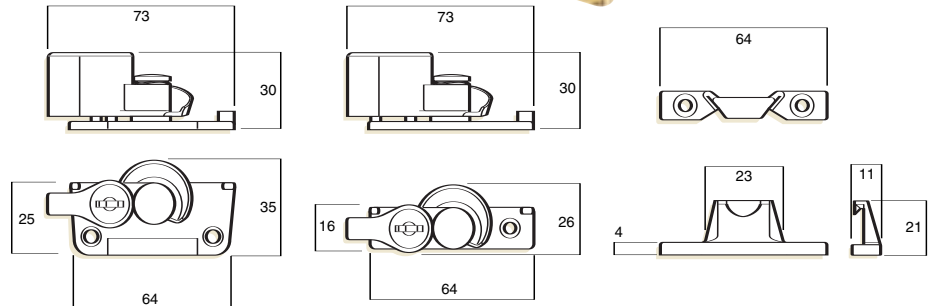

Wide base

Standard base

Standard keeper

Standard Finishes

Available in both plated and polyester powder coat finishes

Bright Gold 02	Satin Chrome 05	Bright Chrome 08	Silver 11
Mahogany 12	Brown 13	Pottery 14	White 16
Black 17	Primrose 19	Stone Beige 28	White Birch 41

Other polyester powder coat finishes available on application.

Accessories

Keepers

Narrow, Zinc diecast	W2725••	805, Stainless Steel	W271704
Standard, Zinc diecast	W2726••	Comalco, Stainless Steel	W271904
Slimline, Zinc diecast	W2792••	Robb & Brown, Stainless Steel	W272004
205, Stainless Steel	W271604	Alcan, Stainless Steel	W272304
405, Stainless Steel	W272404	Wideline, Stainless Steel	W279104
505, Stainless Steel	W271804	4 mm Standard base packer	W2714••

Ordering

•• Denotes finish See price list for available pack/finish combinations

Display Pack

Includes standard base and standard keeper W2731••

Trade Pack

Standard including fixing screws & standard keeper	W2733••
No Screws or Keeper	W2734••
Plain Wide Base including fixing screws & Standard keeper	W2736••
Standard base including fixing screws & Slimline keeper	W2740••

Window Locks

Safety Sash Lock



Aluminium



Timber



Double Hung

Application / Description

Swivel action double hung window lock

Features and Specifications

Swivel type two way action

Self locking snib action – not key lockable

Range of keepers for timber and aluminum window application

Standard 16 mm and wide 26 mm bases available

Display and Trade pack available

Australian made

Keying

Not keyed

Non Standard Finishes

Other finishes available on application

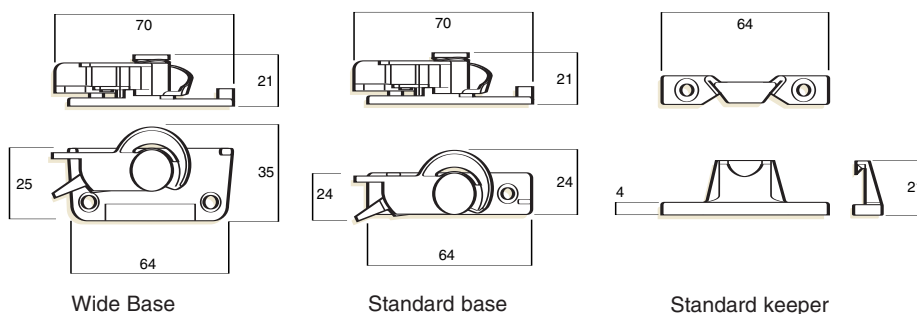

Standard Finishes

Available in both plated and polyester powder coat finishes

	Bright Gold 02		Satin Chrome 05		Bright Chrome 08		Silver 11
	Brown 13		Pottery 14		White 16		Black 17
	Primrose 19		Stone Beige 28		White Birch 41		

Accessories

Keepers

Narrow, Zinc diecast	W2725••	805, Stainless Steel	W271704
Standard, Zinc diecast	W2726••	Comalco, Stainless Steel	W271904
Slimline, Zinc diecast	W2792••	Robb & Brown, Stainless Steel	W272004
205, Stainless Steel	W271604	Alcan, Stainless Steel	W272304
405, Stainless Steel	W272404	Wideline, Stainless Steel	W279104
505, Stainless Steel	W271804	4 mm Standard base packer	W2714••

Ordering

•• Denotes finish. See price list for available pack / finish combinations

Display Pack - includes standard keeper W2712••

Trade Pack

Standard including fixing screws & standard keeper W2702••

No Screws, including standard keeper W2767••

No Keeper or Screws W2769••

Wide Base including fixing screws & standard keeper W2795••

Ordering

Beresfield keeper

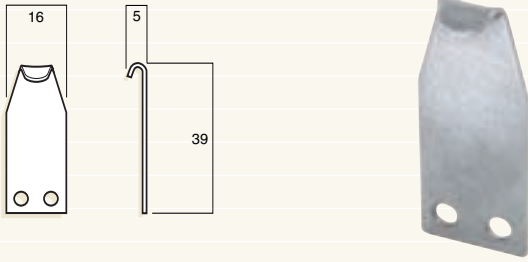

T259 keeper

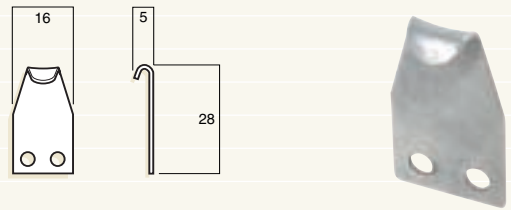

Dowell keeper

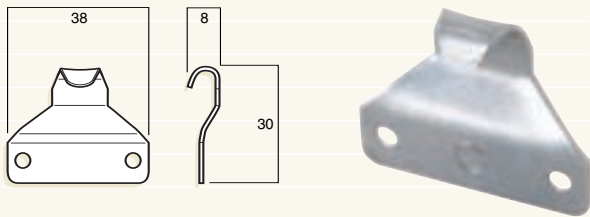

Wideline keeper

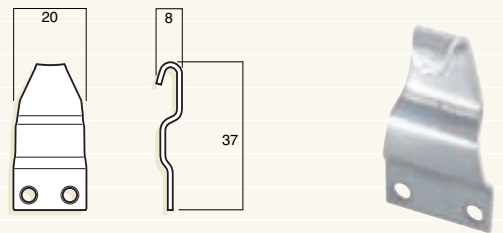

Modified Dowell keeper

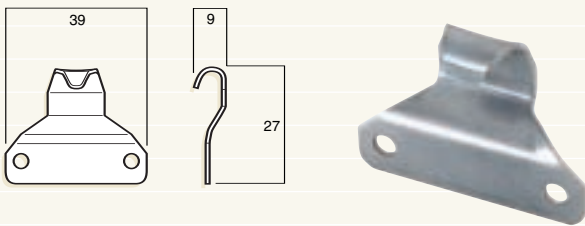

Comalco keeper

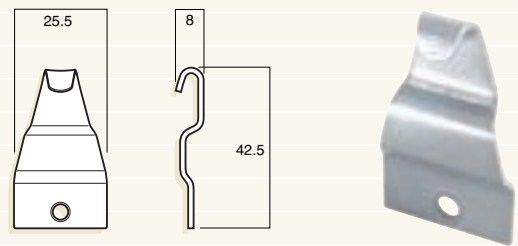

Alcan keeper

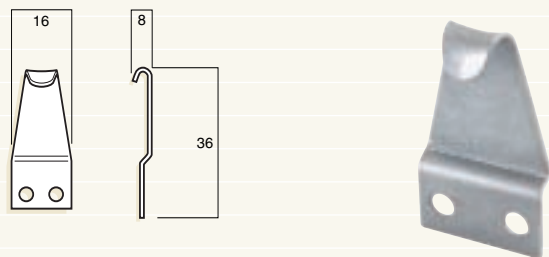

Robb & Brown keeper

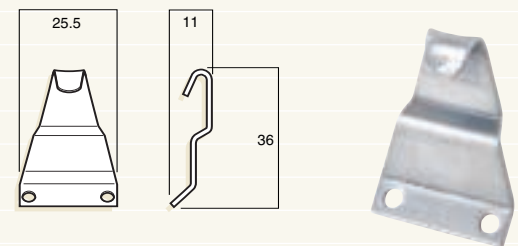

Base packer - aluminium



Altherm keeper

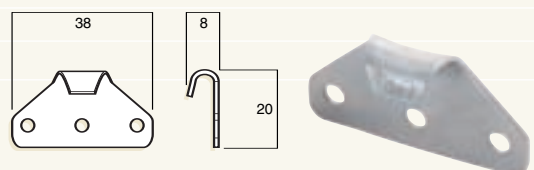

Window Locks

Ordering

Sash lock with Beresfield keeper, no screws	W2762●●
Sash lock with Dowell keeper	W2764●●
Sash lock with modified Dowell keeper	W2765●●
Sash lock with Alcan keeper	W2766●●
4 mm Standard Base aluminium packer	W2714●●
Sash lock with T259 keeper	W2768●●
Sash lock with Clearview keeper	W2766●●
Sash lock with Comalco keeper	W2776●●
Sash lock with Robb & Brown keeper	W2777●●
Sash lock with Altherm keeper	W2793●●

Window Locks

Sliding Window Lock (Diecast)

Aluminium

Timber



Sliding

Application / Description

Premium zinc diecast metal sliding window lock

Features and Specifications

- Available in Non-Lockable & Lockable versions
- Zinc diecast construction
- Stylish contemporary design
- Spring loaded catch for automatic latching
- Strikes includes anti-bow lugs
- Push lever to open, pull lever to close
- Combination pull and fastener
- Strikes and packers available for aluminium and timber applications

Display and Trade pack available
Australian made with imported cylinder

Keying

- 5 disc wafer cylinder
- Two Whitco chrome plated keys
- Can be key alike to other Whitco 5 disc products

Non Standard Finishes

Other polyester powder coat finishes available on application

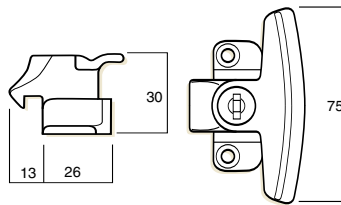

Lockable

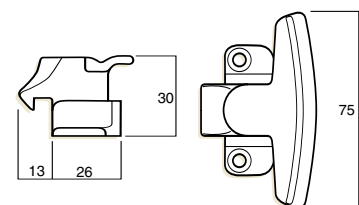

Non lockable

Standard Finishes

Available in both plated and polyester powder coat finishes

 Bright Gold 02	 Satin Chrome 05	 Bright Chrome 08	 Mahogany 12
 Brown 13	 White 16	 Black 17	 Primrose 19
 Stone Beige 28	 White Birch 41		

Other polyester powder coat finishes available on application.

Window Locks

Accessories

Non-lockable body

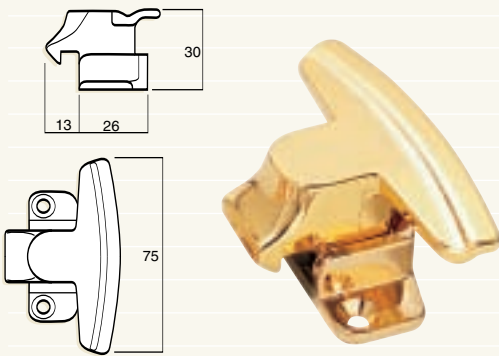

Lockable body

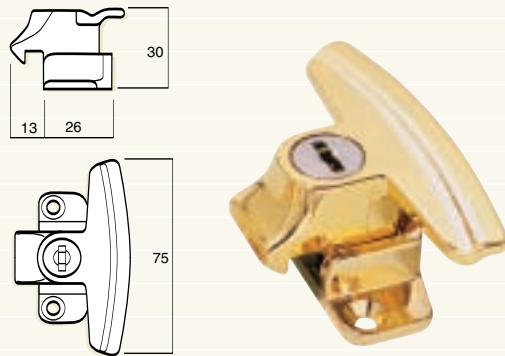

12 mm flat strike

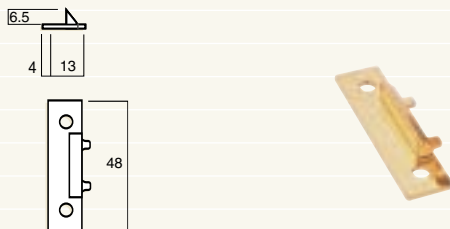

Timber frame strike

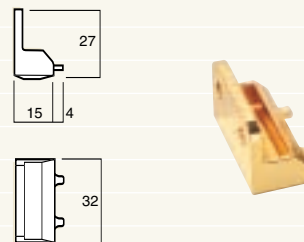

16 mm flat strike

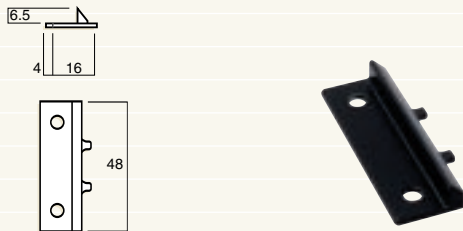

Accessories

Strike packers / polymer



A	
1 mm	W286117
2 mm	W286217
3 mm	W286317

Body packers / polymer

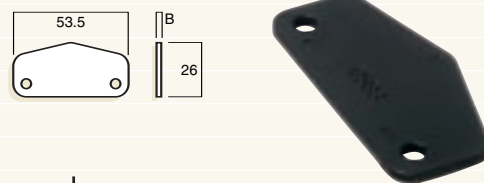

B	
1 mm	W286417
2 mm	W286517
3 mm	W286617
4 mm	W286717

Ordering

•• Denotes finish. See price list for available pack / finish combinations

Display Pack

Lockable with 12 mm and 16 mm aluminium & Timber strikes W2870••

Trade Pack

Non-lockable with 12 mm flat strike W2851••

Non-lockable with 16 mm wide flat strike W2873••

Non-lockable with 22 mm timber frame strike W2852••

Non-lockable with no strike W2853••

Lockable with 12 mm flat strike W2856••

Lockable with 16 mm flat strike W2872••

Lockable with Timber frame strike W2857••

Lockable with No strike (pack of 50) W2858••

Packer – Strike / polymer-suits 12 mm flat strike

1 mm W286117

2 mm W286217

3 mm W286317

Packer – Body / zinc diecast

1 mm W286417

2 mm W286517

3 mm – body W286617

4 mm – body W286917

Strike

16 mm aluminium frame strike W2871••

Window Locks

Series 22 Window Catch

Aluminium

Timber



Casement



Awning

Application / Description

Slim window pull and latch

Features and Specifications

- Slim design
- Positive fastening
- Left hand or right hand versions available
- Zinc diecast construction
- Range of strikes available

Available in Trade pack
Australian made

Keying

Not keyed

Non Standard Finishes

Other finishes available on application





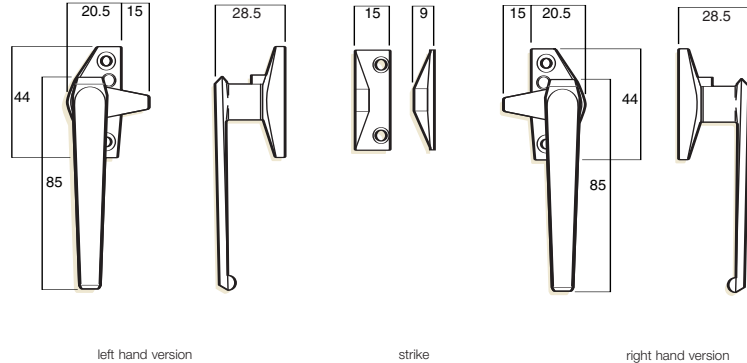

Accessories

No accessories are available for this product



Standard Finishes

Available in both plated and polyester powder coat finishes

 Bright Gold 02	 Satin Chrome 05	 Bright Chrome 08	 Silver 11
 Brown 13	 White 16	 Black 17	

Ordering

•• Denotes finish See price list for available pack / finish combinations

Trade Pack

Standard / with standard body and standard diecast strike	W2201•• (right hand)	W2202•• (left hand)
Fabricator / with no screws	W2203•• (right hand)	W2204•• (left hand)
Pop Rivet Base / with pop rivet base and strike	W2205•• (right hand)	W2206•• (left hand)
Internal Glaze Base / with internal glaze base and strike	W2207•• (right hand)	W2208•• (left hand)
3.5 mm Nylon Strike / with standard base and 3.5 mm strike	W2222•• (right hand)	W2223•• (left hand)
9.0 mm Nylon Strike / with standard base and 9.0 mm strike	W2209•• (right hand)	W2224•• (left hand)

Window Locks

Series 25 Window Lock

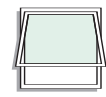

Casement

Awning

Application / Description

Contemporary design lockable pull and latch

Features and Specifications

- Contemporary design
- Both Lockable and No-lock versions available
- Positive fastening
- Left hand or right hand versions available
- Zinc diecast construction
- Range of strikes available



Display and Trade pack available
Australian made with imported cylinder

Keying

- 5 disc wafer cylinder
- Two Whitco chrome plated keys
- Can be key alike to other Whitco 5 disc products

Non Standard Finishes

Other finishes available on application

Accessories

Flat keeper (20 pack) W229104

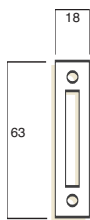

Flat keeper

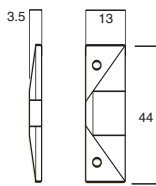

9.0 Nylon Strike

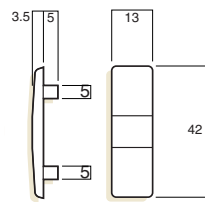

3.5 mm Nylon Strike

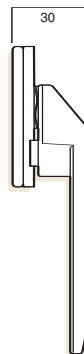

Left hand version

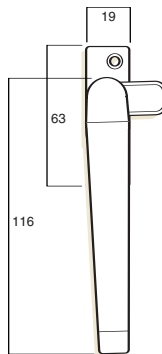

Strike

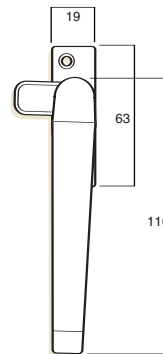

Right hand version

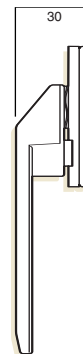

Standard Finishes

Available in both plated and polyester powder coat finishes

Bright Gold 02

Satin Chrome 05

Bright Chrome 08

Mahogany 12

Brown 13

White 16

Black 17

Ordering

•• Denotes finish. See price list for available pack / finish combinations

Display Pack - Lockable

W2261•• (right hand)

W2262•• (left hand)

Trade Pack - Lockable

Standard / standard diecast

W2251•• (right hand)

W2252•• (left hand)

3.5 mm Nylon Strike Base / with standard base and 3.5 mm strike

W2253•• (right hand)

W2254•• (left hand)

9.0 mm Nylon Strike Base / with standard base and 9.0 mm strike

W2255•• (right hand)

W2256•• (left hand)

Trade Pack - Non-Lockable

Standard / standard diecast

W2271•• (right hand)

W2272•• (left hand)

3.5 mm Nylon Strike Base / with standard base and 3.5 mm strike

W2273•• (right hand)

W2274•• (left hand)

9.0 mm Nylon Strike Base / with standard base and 9.0 mm strike

W2275•• (right hand)

W2276•• (left hand)

No Strike / with standard base and no strike

W2259•• (right hand)

W2260•• (left hand)

Visit us at: www.assaabloyasiapacific.com

ASSA ABLOY Sales Offices & Authorised Agents in Asia Pacific

Sales Offices - Australia

Victoria – Head Office

235 Huntingdale Road
Oakleigh VIC 3166
Telephone (03) 8574 3888
Facsimile (03) 8574 3788

Queensland South

450 Sherwood Road
Sherwood QLD 4075
Telephone (07) 3373 5200
Facsimile (07) 3373 5256

Queensland North

Ralph Buck Agencies
15 Mackley Street
Garbutt QLD 4814
Telephone (07) 4779 0177
Facsimile (07) 4775 1480

New South Wales – Commercial

Unit 1/16 Atkinson Road
Taren Point NSW 2229
Telephone (02) 8543 3700
Facsimile (02) 9531 7944

New South Wales – Residential

Unit 8/20-22 Foundry Road
Seven Hills NSW 2147
Telephone (02) 9624 2666
Facsimile (02) 9620 9340

New South Wales – Abloy

5/372 Eastern Valley Way
Chatswood NSW 2067
Telephone (02) 9882 6066

South Australia

182 Magill Road
Norwood SA 5067
Telephone (08) 8139 0403
Facsimile (08) 8364 1975

Western Australia

45 Gladstone Street
East Perth WA 6004
Telephone (08) 9227 9588
Facsimile (08) 9227 8913

Tasmania

23 Antill Street
South Hobart TAS 7000
Telephone (03) 6223 5404
Facsimile (03) 6224 0435

Sales Offices - New Zealand

Auckland – Residential

6 Armstrong Road
North Harbour Industrial Estate
Albany, Auckland, New Zealand
Telephone +64 (0)9 415 7111
Facsimile +64 (0)9 415 7222

Auckland – Sales Office

10 Haultain Street
Eden Terrace
Auckland, New Zealand
Telephone +64 (0)9 634 5590
Facsimile +64 (0)9 634 5589

Christchurch – Sales Office

112 Wordsworth Street
Sydenham
Christchurch, New Zealand
Telephone +64 (0)3 348 2294
Facsimile +64 (0)3 379 4819

Wellington

Display Centre, Level 3,
10 Hutt Road, Petone
Wellington, New Zealand
Telephone +64 (0)4 913 4214
Facsimile +64 (0)4 913 4213

Manufacturing Plants

Victoria

235 Huntingdale Road
Oakleigh VIC 3166
Telephone (03) 8574 3888
Facsimile (03) 8574 3788

Queensland

450 Sherwood Road
Sherwood QLD 4075
Telephone (07) 3373 5200
Facsimile (07) 3373 5256

New Zealand

6 Armstrong Road
North Harbour Industrial Estate
Albany, Auckland, New Zealand
Telephone +64 (0)9 415 7111
Facsimile +64 (0)9 415 7222

Security Merchants Australia

Unit 144/45 Gilby Road
Axxess Business Park
Mount Waverley, Victoria 3149
Telephone +61 (0)3 9558 8455
Facsimile +61 (0)3 9558 8466

Security Merchants New Zealand

8-10 Haultain Street
Eden Terrace
Auckland, New Zealand
Telephone +64 (0)9 355 9240
Facsimile +64 (0)9 307 1752

Export Department

235 Huntingdale Road
Oakleigh VIC 3166 Australia
Telephone +61 (0)3 8574 3888
Facsimile +61 (0)3 8574 3789

Asian Offices

ASSA ABLOY – Malaysia

ASSA ABLOY – Singapore

ASSA ABLOY – Thailand

ASSA ABLOY – Hong Kong

ASSA ABLOY – Shanghai

ASSA ABLOY – Beijing

ASSA ABLOY – Korea

ASSA ABLOY – India

Contact the Export Department,
Australia for details.

Worldwide Distributors

Contact the Export Department,
Australia for details.



ASSA ABLOY

Whitco Warranty

ASSA ABLOY Australia Pty Limited ("ASSA ABLOY") warrants its Whitco products against defects in workmanship and materials for a period of 10 years from the date of purchase by the retail customer, subject to the limitations and exclusions set out in this Warranty. If, within this period the product is found to be defective, and none of the limitations and exclusions set out in this Warranty apply, ASSA ABLOY will supply the same or equivalent product free of charge. This is the only remedy granted by ASSA ABLOY under this Warranty.

Limitations

All window screen and door screen products are warranted for a period of 12 months from the date of purchase by the retail customer. This limitation does not apply to key locks and hinges included in window screen and door screen products, to which the full ten year warranty applies.

Exclusions

This Warranty does not cover:

1. Damage to or malfunction or failure of the Whitco product caused or contributed to by:

- misuse, abuse, accidental or intentional damage;
- improper installation or failure to follow fitting instructions;
- improper maintenance;
- use contrary to instructions provided by ASSA ABLOY;
- fair wear and tear;
- any modification or repair which has not been authorized by ASSA ABLOY;
- use of substitute or replacement parts or cylinders other than genuine ASSA ABLOY parts or cylinders.

2. The cost of:

- removal, replacement or reinstallation of the Whitco product;
- freight costs and travelling time;
- any modification or repairs to a Whitco product, unless authorised by ASSA ABLOY.

3. Damage caused by corrosion when the Whitco product is used in a corrosive environment.

4. Tarnish, damage to or deterioration of soft finishes such as Bronze, Brass and other Antique finishes, which are subject to deterioration due to environmental conditions, frequency of use and other factors.

5. Damage to Gold, Chrome and powder coated finishes caused by damage to the protective layer.

6. Deterioration in colour and performance of polymer materials.

7. Personal injury, property damage or economic loss, however caused.

This Warranty is in addition to and not in substitution for any rights of the purchaser under the Trade Practices Act and state or territory legislation.

